

UNI-T®

UNI-T REED INTERNATIONAL LTD
ISO 9001
Certificate No. 956661

UT216D

Operating Manual



**600A True RMS Digital
Clamp Meters**



P/N:110401104791X

Contents

I. Overview	1
II. Unpacking check	1
III. Codes for safety operation	1
IV. Electric symbols	3
V. External structure	3
VI. Functions of buttons	4
VII. Technical indicators	9
1. General specifications	9
2. Environmental constraints	9
3. Electric specifications	10
VIII. Operation instructions for measurements	13
1. Measurement of AC current	13
2. Measurement of DC current	15
3. Measurement of AC voltage	17
4. Measurement of DC voltage	19
5. Measurement of temperature	20
6. Measurement of resistance	21
7. Conductivity inspection	22
8. Measurement of diode	23
9. Measurement of capacitance	24
10. Measurement of frequency	25
11. Measurement of induced voltage	26
IX. Maintenance and repair	27
1. General maintenance	27
2. Installation and replacement of battery	27

I. Overview

UT216D is a kind of 3 5/6 position AC/DC digital clamp meter ("clamp meter") with stable performance, good safety and high reliability. Taking large scale integrated circuit Σ/Δ converter as the core, its overall circuit is designed with full-range overload protection circuit and unique appearance, which enables it become special electric instrument with excellent performance. It can be used for measuring AC/DC current, AC/DC voltage, resistance, circuit conductivity, diode, capacitance, temperature, frequency, induced voltage and etc.

This Operation Manual covers relevant safety information, warnings and others, please read it carefully and strictly observe all warnings and precautions.

▲ Warning: Before using clamp meter, please read "Codes for Safe Operation" carefully.

II. Unpacking check

Open packing box, take the meter out, and carefully check whether articles listed below are missed or damaged:

- | | |
|----------------------------------|--------|
| 1. Operation Manual----- | 1 pc |
| 2. Pens----- | 1 pair |
| 3. K-type temperature probe----- | 1 pc |
| 4. Cloth bag----- | 1 pc |
| 5. Warranty ----- | 1 pc |

In case of any missing or damage, please contact your supplier immediately.

protection impairment if used in a manner not specified by the manufacturer

probe assemblies used for MAINS measurements CATII 1000V, CATIII 600V according to IEC 61010-031

III. Codes for Safe Operation

Please pay attention to "warning symbols and warning expressions". Warning means situations or actions which are dangerous to users, or may cause damages to meter or measured devices.

This Meter complies with EN 61010-1, 61010-2-032, 61010-2-033, Pollution Degree 2,

Overvoltage Category (CATII 1000V, CATIII 600V) and Double Insulation standards.

CONFORMS TO UL STD 61010-1 and IEC STD 61010-2-032
CERTIFIED TO CSA STD C22.2 NO.61010-1 and 61010-2-032

Ⓒ This product has been tested to the requirements of CAN/CSA-C22.2 No. 61010-1, second edition, including Amendment 1.

CAT II: Applicable to test and measuring circuits connected directly to utilization points (socket outlets and similar points) of the low-voltage MAINS installation.

CAT III: Applicable to test and measuring circuits connected to the distribution part of the building's low-voltage MAINS installation.

1. Before using, check clamp meter and pens to avoid damages or abnormality. If it has found that pens of this clamp meter or shell insulation has been obviously damaged, no indication is on display, or you believe that this clamp meter can't normally operate any more, please do not use this clamp meter.

2. Prohibit using clamp meter before back cover and battery cover have not been covered. Otherwise, electric shock possibly occurs.

3. When measuring, make sure remember fingers shall not be beyond pen's hand-protection part, and not contact exposed electric wires, connector, input terminal not used or circuit under measurement, to avoid electric shock.

4. Before measuring, functional switches must be in correct positions. Prohibit switching when measuring, to avoid damage of clamp meter.













5. Do not apply voltage higher than DC1,000V/AC750V between clamp meter's terminal and earthing to avoid electric shock and damage of clamp meter.

6. Be careful when use this meter to measure DC voltage higher than 42V or AC effective voltage higher than 30V for there exists danger of electric shock at this moment.

7. Do not measure voltage or current higher than allowed input value. If the range of measured value can't be determined, functional range switch shall be in the maximum-rang position. Before measuring on-line resistor, diode or circuit conductivity, all power supply in circuit must be cut off, and discharge all capacitors. Otherwise, measuring results may be not accurate.

8. When "□" is shown on display, battery shall be replaced in time to ensure accuracy of measurement. If clamp meter is out of service for a long period, battery shall be taken out.
9. Please do not change internal wiring of clamp meter arbitrarily to avoid damage of meter and occurrence of possible danger.
10. Do not store and use clamp meter in high temperature, high humidity, flammable, explosive and strong electromagnetic field environment.
11. When conducting maintenance, please use soft cloth and neutral detergent to clean shell of clamp meter. Abrasive compound and solvent are not allowed to avoid corrosion of shell, damage of meter and occurrence of possible danger.

IV. Electric symbols

	Double insulation
	Earthing
	Warning
	AC (alternating current)
	DC (direct current)
	Buzzing on-off
	Diode
	Capacitor
	AC or DC (alternating current or direct current)
	Danger! High voltage!
	Comply with European Union Standards
	This symbol signify the product comply with both USA and Canada requirement

V. External structure (please see Fig.1)

1. Clamp head: sensor device for measuring AC/DC current to get current converted to voltage.
2. Clamp body: a kind of safety design for protecting user's hands from touching dangerous area.

3. Clamp head pulling handle: pull trigger to get clamp head loosen; loosen trigger to get clamp head automatically closed.
4. Rotating switch: select gears of measuring functions.
5. Functional buttons: select basic functions.
6. LCD display area: display measuring data and function symbols.
7. Measuring input terminal: input measuring signal.

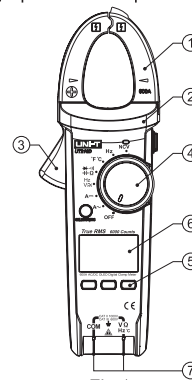

Fig.1

VI. Functions of buttons

SELECT:

Function selection button: effective only in RES/CNT/DIO/CAP and ACV/DCV and TEM gear.

- (1) In RES/CNT/DIO gear, short press SELECT button to switch among three measuring functions, including RES, CNT, DIO and CAP. Rotate knob to RES/CNT/DIO/CAP gear, it defaults to RES function. Under RES function, short press SELECT button one time to switch to CNT function. Under CNT function, short press SELECT button to switch to DIO function. Under DIO function, short press SELECT button to switch to CAP function. Under CAP function, short press SELECT button to switch back to RES function.
- (2) In ACV/DCV gear, short press SELECT button to switch between ACV and DCV functions.

Rotate knob to ACV/DCV gear, it defaults to ACV function. Under ACV function, short press SELECT button to switch to DCV function. Under DCV function, short press SELECT button to switch back to ACV function.

(3) In TEM gear, short press SELECT button to switch between centigrade temperature measuring function and Fahrenheit temperature measuring function. Rotate knob to TEM gear, it defaults to TEM-°C function, under TEM-°C function, short press SELECT button to switch to TEM-°F function.

VFC:

VFC function button: this functional button multiplexes with SELECT button. When long press, execute VFC function, only effective in ACV and ACI gear.

In ACV and ACI gear, long press VFC button to enter into VF voltage, VF current measuring function. In VFC measuring mode, clamp meter can effectively filter HF interference in measuring signal to ensure stability of measuring results. In ACV+VFC mode, voltage gear will be compulsorily locked in 750V range. At this moment, switch the display of VFC voltage value and VFC frequency measuring value by short pressing VFC button. In ACI/VFC mode, current gear will be locked in 600A range, VFC function in current range only can measure VFC current value. In VFC mode, long press VFC button to exit from VFC measuring function and return to normal measuring status.

HOLD:

Reading-holding button: effective in all gears.

In normal measuring mode, short press HOLD button one time to enter into data holding mode, clamp meter will not update measuring data, and display value will be locked and remain unchanged. On the upper left of display, "H" symbol will be displayed, indicating entering into data holding mode. In data holding mode, short press HOLD button, rotate knob or press SELECT button to exit from data holding function.

SETUP:

Setup function button: this functional button multiplexes with HOLD button. When long press, execute SETUP function, effective in all gears.

In any non-setting mode, press SETUP button for more than 1S to enter into setup mode. In setup mode, users can set up auto shutdown time, brightness of OLED display and etc. It firstly defaults to item of SETUP1: setup of auto shutdown time. In this interface, press MAX/MIN button to adjust auto shutdown time to be longer, and press REL/ZERO button to adjust auto shutdown time to be shorter, and adjustment range is 1~30min. the meter will automatically enter into sleep mode depending on set time and "APO" symbol is displayed on the upper left of display to indicate opening of auto shutdown function. When 1min is displayed in display, continue to press REL/ZERO button to close APO function, "OFF" symbol is displayed, auto sleep function will be closed, and the meter will remain under operation status until the battery is used out or users manually close it. If auto shutdown function is closed, "APO" symbol will not be displayed on the upper left of display.

In SETUP1 setting interface, press SELECT button to enter into item of SETUP2: setup of OLED brightness. In this interface, press MAX/MIN button to adjust OLED brightness to be stronger, and press REL/ZERO button to adjust OLED brightness to be weaker, and adjustment range is 0~100%. The brightness of OLED display will be real-time adjusted depending on percentage set by users.

In SETUP1 or SETUP2 interface, press SETUP button for at least 1S to exit from setup, and mode and return back to normal measuring mode.

MAX/MIN:

Max/min value measuring button: effective under functions except CNT, DIO, FRQ and NCV.

In normal measuring mode, short press MAX/MIN button one time to enter into max/min value holding mode. The meter now begins to collect max value, min value and average value obtained in the process of measuring, such values will be displayed on main display and current measuring value will be displayed on secondary display. Meanwhile, "MAXMIN" symbol will be displayed on the upper left to indicate that enter into max/min value holding mode currently. It firstly defaults to entering into MAX mode, and main display displays max value. In MAX mode, short press MAX/MIN button to

enter into MIN mode, and main display displays min value. In MIN mode, short press MAX/MIN button to enter into AVG mode, and main display displays average value. In AVG mode, short press MAX/MIN button to return back to MAX mode. Whether it is in MAX, MIN or AVG mode, press MAX/MIN button for more than 1S, rotate knob or press SELECT button to exit from max/min value mode and return back to normal measuring mode.

In max/min value measuring mode, it also will enter into data holding mode by pressing HOLD button, clamp meter will not update measuring data, but max value, min value and average value still can be browsed by pressing MAX/MIN button.

When exit from max/min value mode, HOLD status will be cancelled together.

REL:

Relative value measuring button: effective under functions except CNT, DIO, FRQ, NCV and DCI.

In normal measuring mode, short press REL button to enter into relative value measuring mode. In relative value measuring mode, main display displays Dn-Df, secondary display displays Df, in which, Df is the last measuring value (relative value) before pressing REL button, and Dn is current measuring value. Meanwhile, "REL" symbol will be displayed on the upper left of display to indicate that enter into relative value mode currently.

In REL mode, short press REL button again, rotate knob or press SELECT button to exit from relative value measuring mode and return back to normal operation status. In relative value measuring mode, it will also enter into data holding mode by press HOLD button, and clamp meter will not update measuring data. When exit from relative value measuring mode, HOLD status will be cancelled as well.

ZERO:

Data clearing button: this functional button multiplexes with REL button, effective only under DCI function.

Clamp head will induce earth magnetic field to produce induced voltage when no signal has been measured, so there exists base number in DCI gear, and such number will change with different storage position and storage direction of clamp meter. When conduct DCI measurement, base number must be deducted.

In DC current gear, short press ZERO button to enter into zero clearing mode to deduct base number in DC current measuring function. In zero clearing mode, main display displays Dn-Df, Df is the DCI base number before pressing ZERO button, Dn is current measuring value. Meanwhile, "ZERO" symbol will be displayed on the upper left of display to indicate that enter into zero clearing mode currently.

When pressing ZERO button again in zero clearing mode, Df will be updated again, and Dn-Df after updating will be displayed. Press ZERO button for more than 1S or rotate knob to exit from zero clearing function. It will also enter into data holding mode when pressing HOLD button in zero clearing mode. Clamp meter will not update measuring data. When exit from zero clearing mode, HOLD status will also be cancelled.

INRUSH:

Inrush current measuring button: this functional button multiplexes with REL button, effective only under ACI function. In AC current gear, long press INRUSH button to enter into inrush current measuring mode, "INRUSH" symbol is displayed on the top of display for indication. In inrush current measuring mode, AC current gear will be locked in 600A range, main display displays 0 when no inrush current has been detected. After startup of equipment to be measured, inrush current in power supply circuit will trigger meter to capture, and get the max value captured displayed on main display, to complete inrush current measuring.

After completion of one-time inrush current measurement, make sure long press INRUSH button to exit from inrush current measuring mode, and then restart to measure inrush current.

FLASHLIGHT:

LED lamp on-off button: it is effective when clamp meter is on. Short press one time to get lamp on, and then short press FLASHLIGHT button for one time to turn lamp off.

VII. Technical indicators

1. General specifications

Liquid crystal display : 6,000 maximally displayed;

Polarity display: positive pole and negative pole automatically displayed;

Overload display: displayed as "OL" or "-OL";

Battery voltage display: Vbtttery vdisplaying 3/3 power left;
3.9Vlay<4.2V, displaying 2/3 power left;
3.6V, d<3.9V, displaying 1/3 power left;
Vb<3.6V, displaying 0 power left, battery shall be replaced;

Sampling rate: About 3 times per second;

Types of sensor: Hall effect sensor for DC/AC measurement;
Measuring position error: ±ng position error - ;d; left, will occur when measure current, for source to be tested has not been placed in the central position of clamp head;

Impact-resistance strength: able to bear one-meter landing impact;

Max size of clamp head opening : Φ30mm;

Max size of predicted current wire : Φ30mm;

Effect of electromagnetic field: unstable or incorrect reading may be displayed when there is electromagnetic interference in measuring environment;

Power supplydemand: 3 AAA 1.5V alkaline batteries;

Auto shutdown function: auto shutdown time can be set (1~30min), or close this function as required;

Size: 228mmshutdwn ti;

Weight: About 265g (including battery);

2. Environmental constraints

Operation environment : used indoor;

Altitude: <2,000m;

Safety standards: IEC61010-1, IEC61010-2-032,
CAT II 1000V CAT III 600V;

Pollution class : 2;

Operation temperature and humidity :

0°C~30°C (not higher than 80%RH)

30°C~40°C (not higher than 75%RH)

40°C~50°C (not higher than 45%RH)

Storage temperature and humidity:

20°C~+60°C (not higher than 80%RH)

3. Electric specification

Accuracy: ±(% reading+ number), calibration period is one year;

Environmental temperature: 23 C ± 5 C;

Environmental humidity: ≤ 80%RH;

Temperature coefficient: 0.1d is one yea C;

(1) Measurement of AC current (A~)

ACI	Range	Resolution ratio	Accuracy	Overload protection
	60.00A	0.01A		
600.0A	0.1A			
ACI+VFC	600A	0.1A	±(7.5%+5)	

Main display: Current true RMS;

Secondary display: Frequency;

Frequency response: 50Hz ~ 60Hz

(2) Measurement of DC current (A=)

DCI	Range	Resolution ratio	Accuracy	Overload protection
	60.00A	0.01A		
600.0A	0.1A			

Base number of DCI shall be cleared by pressing ZERO button.

(3) Measurement of AC voltage (V~)

ACV	Range	Resolution ratio	Accuracy	Overload protection	
	6.000V	0.001V			± (1.2%+5)
	60.00V	0.01V			
	600.0V	0.1V	± (1.2%+3)		
750V	1V	± (1.5%+5)			
ACV+VFC	600V		0.1V	±(6.5%+5)	

Main display: voltage true RMS;

Secondary display: frequency;

Input impedance: ≥ 10MΩ;

Frequency response: 45Hz ~ 400Hz (≤400mV:50~100Hz)

(4) Measurement of DC voltage (V)

DCV	Range	Resolution ratio	Accuracy	Overload protection
	600.0mV	0.1mV	± (1.0%+5)	DC 1000V
	6.000V	0.001V	± (0.8%+3)	
	60.00V	0.01V		
	600.0V	0.1V		
1000V	1V	± (1.0%+5)		

Input impedance: onvolt

(5) Measurement of temperature (°C/°F)

TEM	Range	Resolution ratio	Accuracy	Overload protection
	-40°C~40°C	1°C	± (3.0%+5)	750Vrms MAX
	40°C~400°C		± (2.5%+3)	
	400°C~1000°C		± (3.0%+5)	
	-40°F~104°F	1°F	± (3.0%+5)	
	104°F~752°F		± (2.5%+3)	
	752°F~1832°F		± (3.0%+5)	

(6) Measurement of resistance (Ω)

RES	Range	Resolution ratio	Accuracy	Overload protection
	600.0Ω	0.1Ω	± (1.2%+2)	750Vrms MAX
	6.000kΩ	0.001kΩ	± (1.0%+2)	
	60.00kΩ	0.01kΩ		
	600.0kΩ	0.1kΩ		
	6.000MΩ	0.001MΩ	± (1.2%+2)	
	60.00MΩ	0.01MΩ	± (1.5%+5)	

(7) Conductivity inspection (••)

CNT	Range	Resolution ratio	Accuracy	Overload protection
	600.0Ω	0.1Ω	≤ 30Ω Buzzer sounds	750Vrms MAX
			≥ 100Ω Buzzer doesn't sound.	

Open-circuit voltage is about 1.2V.

(8) Diode testing (▶)

DIO	Range	Resolution ratio	Accuracy	Overload protection
	6.000V	0.001V	0.5V~0.8V	750Vrms MAX

Open-circuit voltage is about 3.3V

(9) Measurement of capacitance (F)

CAP	Range	Resolution ratio	Accuracy	Overload protection
	60.00nF	0.01nF	± (4.0%+20)	750Vrms MAX
	600.0nF	0.1nF		
	6.000uF	0.001uF		
	60.00uF	0.01uF		
	600.0uF	0.1uF		
	6.000mF	0.001mF	± (10%)	
60.00mF	0.01mF	Only for reference		

Conduct measurement in REL mode

(10) Measurement of frequency (Hz)

	Range	Resolution ratio	Accuracy	Overload protection
FRQ	60.00Hz	0.01Hz	± (0.1%+4)	750Vrms MAX
	600.0Hz	0.1Hz		
	6.000kHz	0.001kHz		
	60.00kHz	0.01kHz		
	600.0kHz	0.1kHz		
	1.000MHz	0.001MHz		

Measuring range: 10Hz ~ 1MHz

≤asuring range: 10Hz ~ 1MHz

≤asuring raVrms ≤ a ≤ 20Vrms;

(11) Measurement of induced voltage (NCV)

	Range	Accuracy
NCV	NCV	Induced voltage induced v Distance oltage induced voltage (NCV) by pressin

VIII. Operation instructions for measurements

1.Measurement of AC current (shown as Fig. 2)

- Set AC current measuring function gear .
Rotate knob to start it up and make pointer direct to "A~", clamp meter enters into AC current measuring function gear;
- Connect to current signal to be measured.
Press trigger to make clamp head of clamp meter open, connect to current conductor to be measured and make it remain in the middle, then, loose trigger to make clamp head close. Clamp meter will automatically select proper range, main display will display true RMS of AC current, secondary display will display frequency of AC current, frequency measuring range is 50Hz~60Hz.

⚠ Warning: Maximum measuring current shall not higher than AC600A when measuring AC current.

⚠ Note: AC current measuring gear may enter into VF current measuring function by long pressing VFC button (multiplex with SELECT button), and into inrush current measuring function by long pressing INRUSH button (multiplex with REL button).

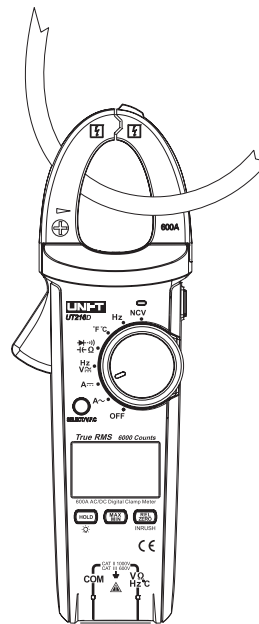

Fig. 2

2.Measurement of DC current (shown as Fig. 3)

- (1) Set DC current measuring function gear.

Rotate knob to start it up and make pointer direct to "A $\overline{=}$ ", clamp meter enters into DC current measuring function gear;

- (2) Clear base number in DC current measuring gear.

Clamp head sensor will induce earth magnetic field and surrounding magnetic field, so, there generally is base number in DC current gear when no measurement is conducted. Therefore, before measuring DC current, it needs to press "ZERO" button to clear base number, and conduct measurement after zero clearing;

- (3) Connect to current signal to be measured.

Press trigger to make clamp head of clamp meter open, connect to current conductor to be measured and make it remain in the middle, then, loose trigger to make clamp head close. Clamp meter will automatically select proper range. If current direct is in consistent with the direction where clamp head points, display will display positive current measuring value, otherwise, it will display negative current measuring value;

- ⚠ Warning: Maximum current shall not be higher than DC600A when measuring DC current.

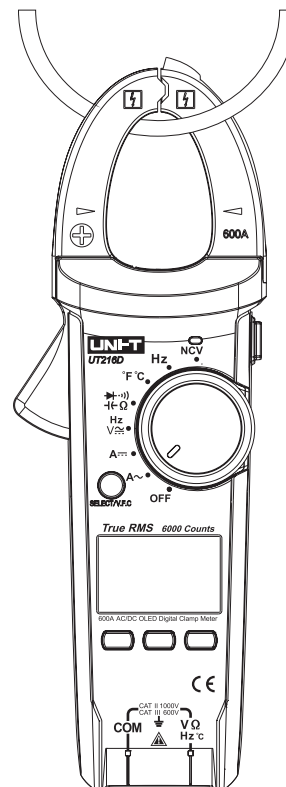

Fig. 3

3.Measurement of AC voltage (shown as Fig. 4)

(1) Insert pen

Insert black pen into “COM” input terminal, red pen into “VΩ” input terminal, and prepare to measure;

(2) Set AC voltage measuring function gear.

Rotate knob to start it up and make pointer direct to “V_{AC}”, clamp meter defaults to entering into AC voltage measuring function gear;

(3) Connect to voltage to be measured

Get red and black pens placed at the two terminals of voltage to be measured, clamp meter will automatically select proper range, main display will display true RMS of AC voltage currently measured. When voltage value is higher than AC30V, display will display high voltage warning symbol to indicate the danger of electric shock. Secondary display displays frequency of AC voltage, frequency measuring range is 45Hz~400Hz.

⚠ Warning: AC voltage measuring range shall not higher than AC750V.

⚠ Note: AC voltage measuring gear may enter into VF voltage measuring function by long pressing VFC button (multiplex with SELECT button).

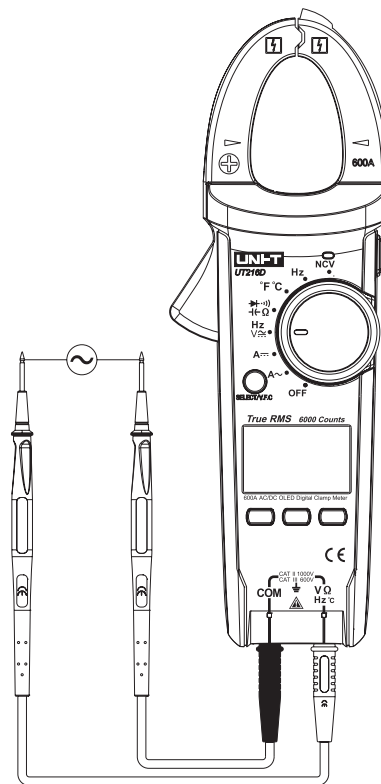

Fig. 4

4. Measurement of DC voltage (shown as Fig. 5)

- (1) Insert pen
Insert black pen into "COM" input terminal, red pen into "VΩ" input terminal, and prepare to measure;
- (2) Set DC voltage measuring function gear.
Rotate knob to start it up and make pointer direct to "V $\overline{\text{DC}}$ ", clamp meter defaults to entering into AC voltage measuring function gear, press SELECT button to switch clamp meter function to DC voltage measuring gear;
- (3) Connect to voltage to be measured.
Get red and black pens placed at the two terminals of voltage to be measured, clamp meter will automatically select proper range, main display will display value of DC voltage currently measured. If electric potential at red pen terminal is higher than that at black terminal, display will display positive voltage value. Otherwise, it will display negative voltage value. When voltage value is higher than DC42V, display displays high voltage warning symbol to indicate the danger of electric shock.

⚠ Warning: DC voltage measuring range shall not higher than DC1000V.

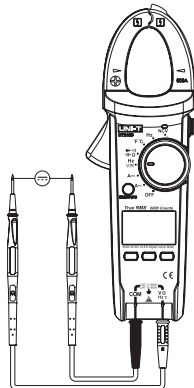

Fig. 5

5. Measurement of temperature (shown as Fig. 6)

- (1) Insert K-type temperature probe
Insert K-type temperature probe into input terminal in the specified positive and negative direction, in which, "COM" input terminal shall be connected to the negative pole of K-type probe, and "VΩ" input terminal connected to the positive pole of K-type probe;
- (2) Set temperature measuring function gear.
Rotate knob to start it up and make pointer direct to "°C°F", clamp meter defaults to entering into centigrade temperature measuring function gear, press SELECT button to switch between centigrade temperature and Fahrenheit temperature;
- (3) Use K-type probe to measure object temperature.
Make temperature probe contact the surface of object to be measured, temperature measured will be displayed on main display. Measuring value can be read after the reading is stable.

⚠ Warning: Environmental temperature of the place where the instrument is placed shall not be higher or lower than 18~28°C, otherwise, measuring error may occur, and such error may be even obvious in low temperature environment.

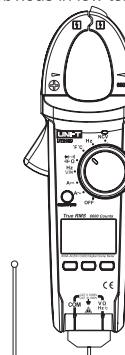

Fig. 6

6.Measurement of resistance (shown as Fig. 7)

- (1) Insert pen
Insert black pen into “COM” input terminal, red pen into “VΩ” input terminal, and prepare to measure;
- (2) Set resistance measuring function gear.
Rotate knob to start it up and make pointer direct to “Ω”, clamp meter defaults to entering into resistance measuring function gear;
- (3) Connect to resistor to be measured.
Make red and black pens placed at the two terminals of resistor to be measured, clamp meter will automatically select proper range, main display will display measuring value of resistor;

⚠Warning: When measuring on-line resistor, make sure cut off circuit power supply, and discharge all residual charge in all capacitor before connection of resistor. Separate elements from circuit and then conduct measurement to get more accurate result.

⚠Note: In 600 range, it is suggested that short out pens, press REL button to deduct short-circuit base number of pens, and then conduct measurement, to eliminate pens' influence on resistor.

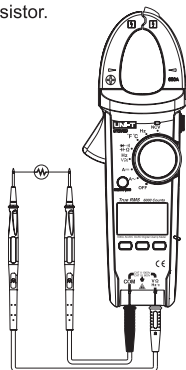

Fig. 7

7.Conductivity inspection (shown as Fig. 8)

- (1) Insert pens
Insert black pen into “COM” input terminal, red pen into “VΩ” input terminal, and prepare to measure;
- (2) Set conductivity inspection function gear
Rotate knob to start it up and make pointer direct to “•|||”, clamp meter defaults to entering into resistance measuring function gear, press SELECT button to switch to conductivity inspection function gear;
- (3) Make red and black pens placed at the two terminals to be measured. If measuring resistance is lower than 30Ω, buzzer will sound for a long time; if measuring resistance is between 30Ω and 100Ω, buzzer may sound or not sound, if measuring resistance is higher than 100Ω, buzzer doesn't sound.

⚠Warning: When measuring conductivity, make sure cut off circuit power supply, and discharge all residual charge in all capacitor before connection of terminals to be measured

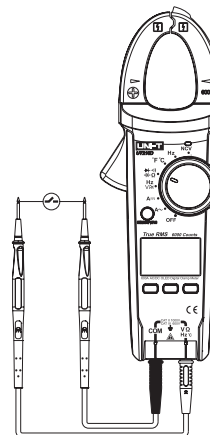

Fig. 8

8.Measurement of diode (shown as Fig. 9)

- (1) Insert pens
Insert black pen into “COM” input terminal, red pen into “VΩ” input terminal, and prepare to measure;
- (2) Set diode measuring function gear.
Rotate knob to start it up and make pointer direct to “▶”, clamp meter defaults to entering into resistance measuring function gear, press SELECT button to switch to diode measuring function gear;
- (3) Connect to diode to be measured.
Make red pen and black pen separately placed at the positive pole and negative pole of diode, main display will display positive conductivity voltage value of diode of measured diode. If red pen and black pen are wrongly connected, display will display over-range symbol “OL”.

⚠Warning: When measuring diode on-line, before connection of diode, make sure cut off circuit power supply, and discharge all residual charge in all capacitor. Separate elements from circuit and then conduct measurement to get more accurate result.

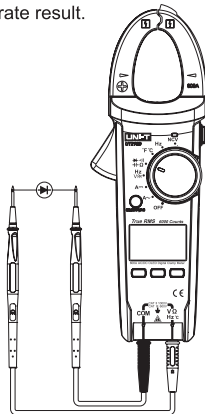

Fig. 9

9.Measurement of capacitance (shown as Fig. 10)

- (1) Insert pens
Insert black pen into “COM” input terminal, red pen into “VΩ” input terminal, and prepare to measure;
- (2) Set capacitance measuring function gear.
Rotate knob to start it up and make pointer direct to “-f-”, clamp meter defaults to entering into resistance measuring function gear, press SELECT button to switch to capacitance measuring function gear;
- (3)Connect to capacitor to be measured
Make red pen and black pen separately placed at the two terminal of capacitor to be measured, clamp meter automatically select proper range, main display will display measuring value of capacitor current measured;

⚠Warning: When measuring capacitor on-line, before connection of capacitor, make sure cut off circuit power supply, and discharge all residual charge in all capacitor. Separate elements from circuit and then conduct measurement to get more accurate result.

⚠Note: In 50nF range, it is suggested to firstly press REL button to deduct open-circuit base number of pens and then conduct measurement to eliminate influence of parasitic capacitance of pens.

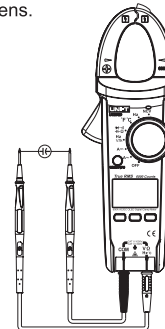

Fig. 10

10. Measurement of frequency (shown as Fig. 11)**(1) Insert pens**

Insert black pen into “COM” input terminal, red pen into “V Ω ” input terminal, and prepare to measure;

(2) Set capacitance measuring function gear.

Rotate knob to start it up and make pointer direct to “Hz”, clamp meter enters into frequency measuring function gear;

(3) Connect to frequency to be measured.

Make red pen and black pen placed at the two terminals of frequency signal to be measured, clamp meter will automatically select proper range, main display will display frequency value currently measured;

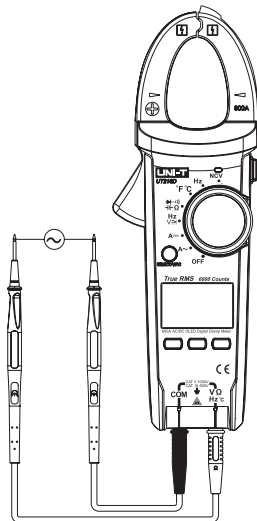

Fig. 11

11. Measurement of induced voltage (shown as Fig. 12)**(1) Set capacitance measuring function gear**

Rotate knob to start it up and make pointer direct to “NCV”, clamp meter enters into induced voltage measuring function gear;

(2) Measure induced voltage

Induced voltage sensor is mounted at the bulge which is at the front end of clamp meter’s clamp head, and such sensor can induce whether there is AC voltage or electromagnetic field in the space. When measuring, make the front end of clamp meter’s clamp head close to conductor to be measured for induction and probing.

According to size of induced voltage, main display will display four classes: “-”, “-”, “-”, “-”. The greater the induced voltage is, the higher the class displayed is.

When measuring distance is shorter than 10mm and voltage measured is higher than 100Vrms, clamp meter will send out buzzing alarming, and NCV_LED also will flashes.

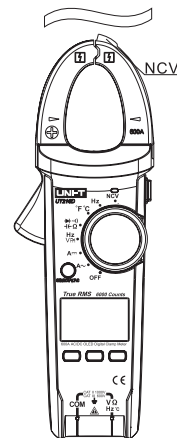

Fig. 12

IX.Maintenance and repair

⚠ Warning: In order to avoid electric shock, please remove testing pens before opening back cover.

1.General maintenance

- a.Maintenance and service of this clamp meter must be completed by qualified professional maintenance personnel or designed maintenance departments.
- b.Regularly use dry cloth to clean shell, but abrasive compound or detergent with solvent are not allowed.

2.Installation and replacement of battery

The power of this product is supplied by 3 AAA 1.5V batteries. Please follow following sequence to install or replace battery:

- a.Shut down this product. Please remove testing pens at input terminal.
- b.Make panel of this product down, loose screws on battery box, take down battery cover, take out batteries, and install new batteries according to polarity instruction.
- c.Please use batteries in the same model. Please do not install improper batteries.
- d.After installation of new batteries, install battery cover and tighten screws.

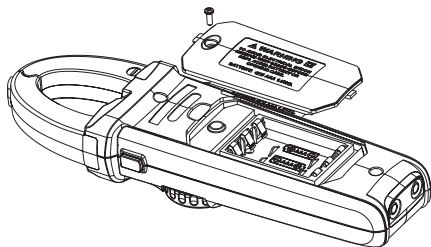

Fig. 13

The contents of this Operation Manual shall be subject to change without prior notice.

Manufacturer:
Uni-Trend Technology (China) Limited
No 6, Gong Ye Bei 1st Road
Songshan Lake National High-Tech Industrial
Development Zone, Dongguan City
Guangdong Province
China
Postal Code:523 808

Headquarters:
Uni-Trend Group Limited
Rm901, 9/F, Nanyang Plaza
57 Hung To Road
Kwun Tong
Kowloon, Hong Kong
Tel: (852) 2950 9168
Fax: (852) 2950 9303
Email: info@uni-trend.com
<http://www.uni-trend.com>